

FNR1608series

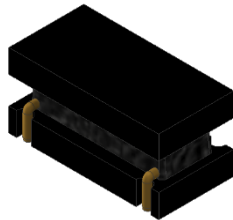

CONSTRUCTION

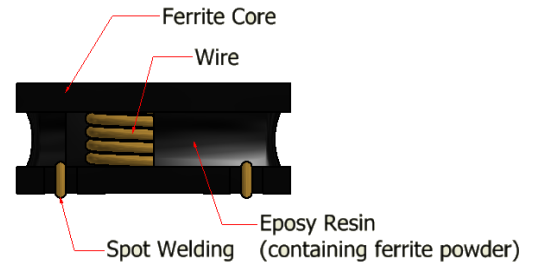

FEATURES

Magnetically structure
Low DC resistance
Large Current Capability

APPLICATIONS

Hard Disk Drives
Car audio equipment
Tablet PC
Navigation system
SSD
Touch Panel

SPECIFICATIONS

Operating temperature range	-40 to +125°C
Storage temperature range	Under 25°C
Packaging style	Taping
Quantities	3,000 pieces/reel

SHAPE AND DIMENSIONS

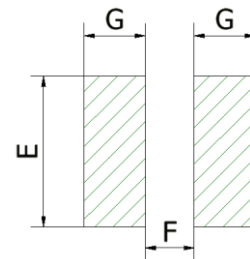
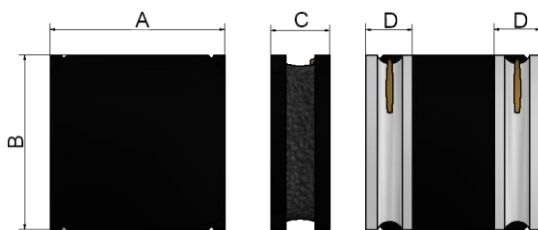

(Unit: mm)

TYPE	A	B	C	D	E	F	G
FNR160808	1.6±0.2	0.8±0.2	0.8max	0.4±0.2	0.9	0.6	0.6

PRODUCT IDENTIFICATION (ex.)

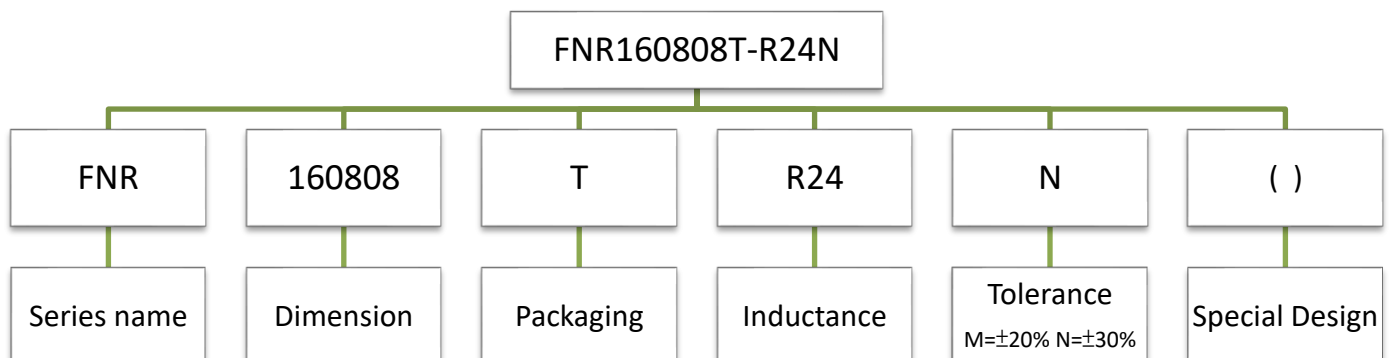

ELECTRICAL CHARACTERISTICS

Part No.	Inductance (uH)	Inductance tolerance	Test Frequency (MHz)	DC Resistance (Ω) \pm 20%	Saturation current Isat(mA)		Temperature rise current Irms(mA)	
					Typ.	Max.	Typ.	Max.
FNR160808T-R24N	0.24	\pm 30%	1	0.044	1800	1600	1400	1100
FNR160808T-R47N	0.47	\pm 30%	1	0.095	1250	1000	1000	850

*The saturation current value (Isat) is the DC current value having inductance decrease down to 30% (at 25°C)

*The temperature rise current value (Irms)is the DC current value having temperature increase up to 40°C (at 25°C)

*Rated current: smaller value of either Isat or Irms.

RECOMMENDED SOLDERING CONDITIONS

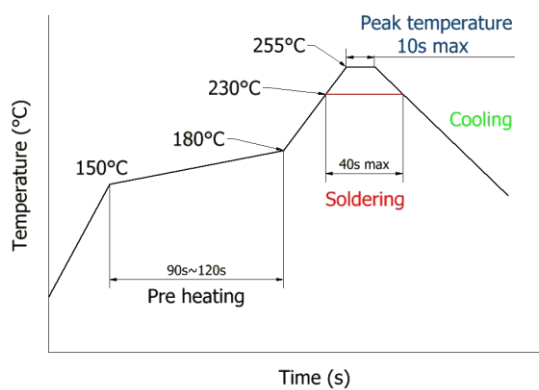

PACKAGE

(1) Taping specifications

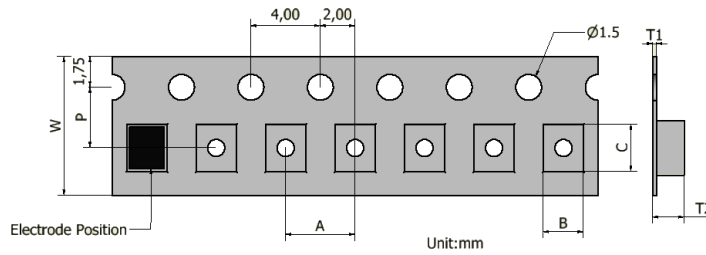

Type	W	P	A	B	C	T1	T2
FNR160808	8	3.5	4.0	1.0	1.8	0.23	1.0

(2) Reel Specifications

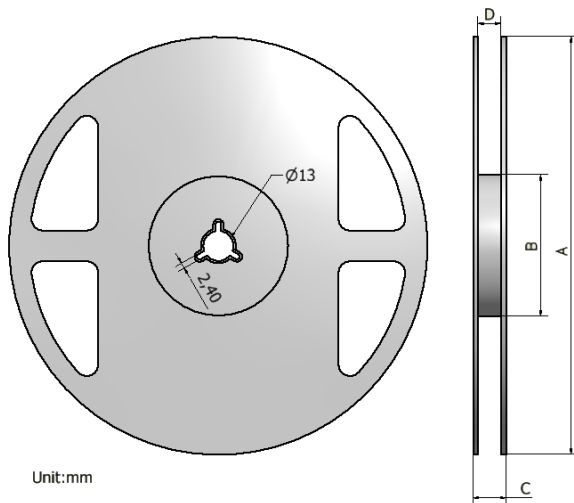

Unit:mm

Type	A	B	C	D	Q'ty/Reel
FNR160808	180±0.1	60±0.1	14.5±0.1	10±0.15	3000

Label

Wire Wound Power Inductors
 FNR1608□□T-□□□M/N
 3,000PCS
 Lot No. _____
 FUMIWA TECHNIAL CO., LTD.

Type	Q'ty
PCS/Reel	3000
Reel/inner Box	15000
Inner Box/Carton	60000