

MFNR3008

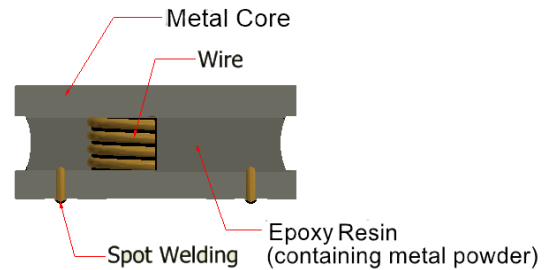

CONSTRUCTION

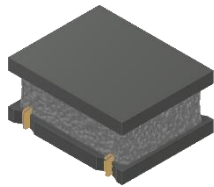

FEATURES

metal material core provides large saturation current
Low DC resistance

APPLICATIONS

Tablet PC
Smart Phone
Car audio equipment
SSD

SPECIFICATIONS

Operating temperature range	-40 to +125°C
Storage temperature range	Under 25°C
Packaging style	Taping
Quantities	4000 pieces/reel

SHAPE AND DIMENSIONS (mm)

RECOMMENDED PATTERN(mm)

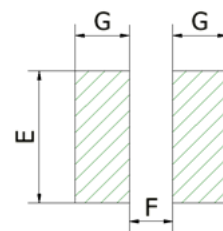
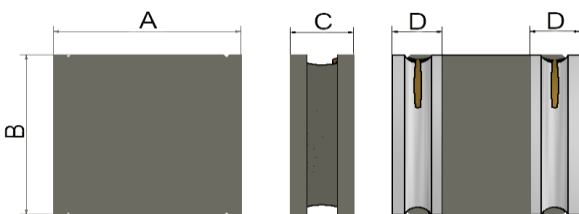

TYPE	A	B	C	D	E	F	G
MFNR3008	3.1±0.2	3.1±0.2	0.8max	0.9±0.2	3.2	1	1.1

PRODUCT IDENTIFICATION (ex.)

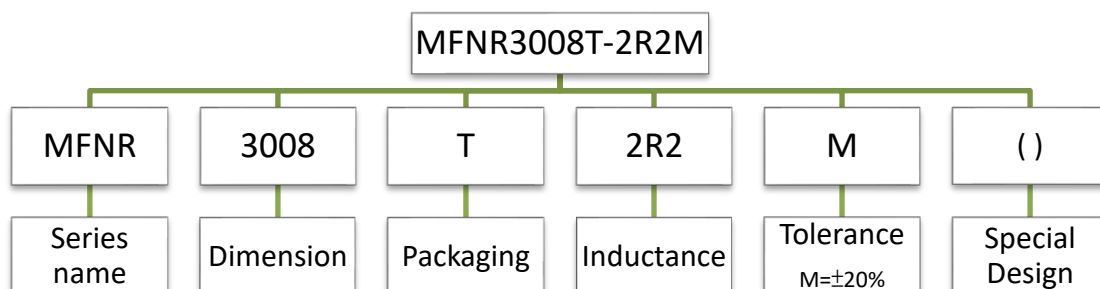

ELECTRICAL CHARACTERISTICS

Part No.	Inductance (uH)	Inductance tolerance	Test Frequency (MHz)	DC Resistance (Ω)		Saturation current Isat(mA)		Temperature rise current Irms(mA)	
				Typ.	Max.	Typ.	Max.	Typ.	Max.
MFNR3008T-2R2M	2.2	±20%	1	0.210	0.260	2800	2600	1800	1600
MFNR3008T-3R3M	3.3	±20%	1	0.305	0.366	2000	1700	1500	1400
MFNR3008T-4R7M	4.7	±20%	1	0.446	0.535	1400	1200	1000	900
MFNR3008T-100M	10	±20%	1	1.176	1.411	1200	1000	800	700

*The saturation current typical is the initial L value having inductance decrease down to 30% (at 25°C)

*The temperature rise current typical is temperature will rise by 40°C(at 25°C)

*Rated current: smaller value of either Isat or Irms.

RECOMMENDED SOLDERING CONDITIONS

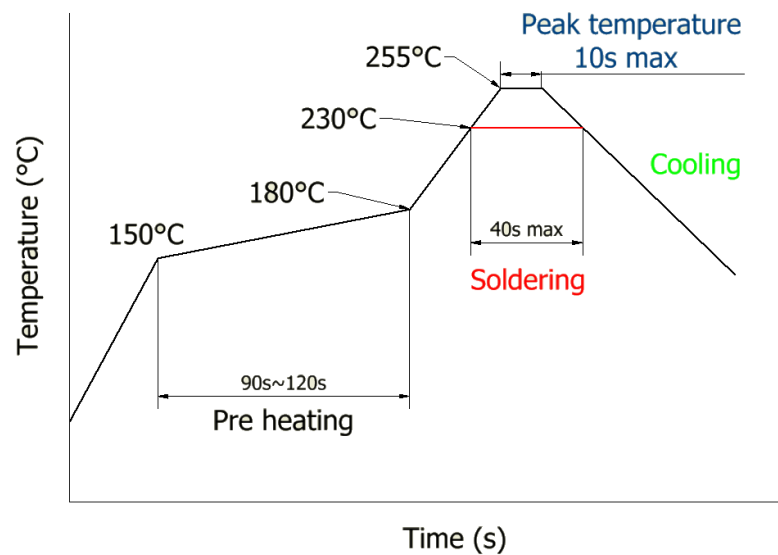

PACKAGE

(1) Taping specifications

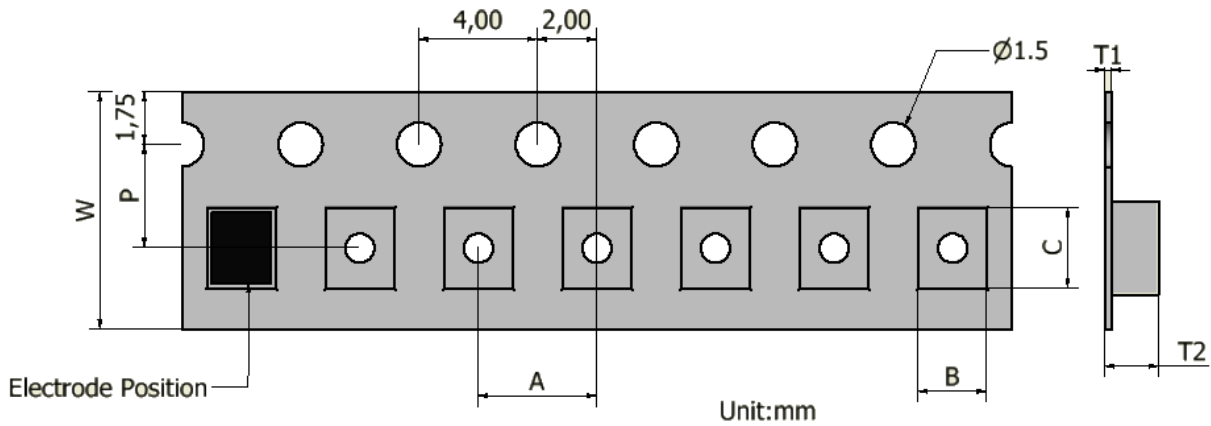

Type	W	P	A	B	C	T1	T2
MFNR3008	8	3.5	4.0	3.2	3.2	0.2	1.0

(2) Terminal part and leader part tape

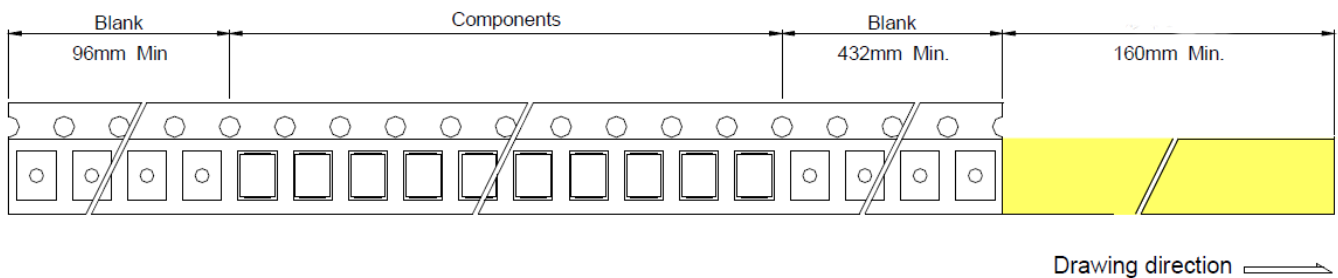

(3) Reel Specifications

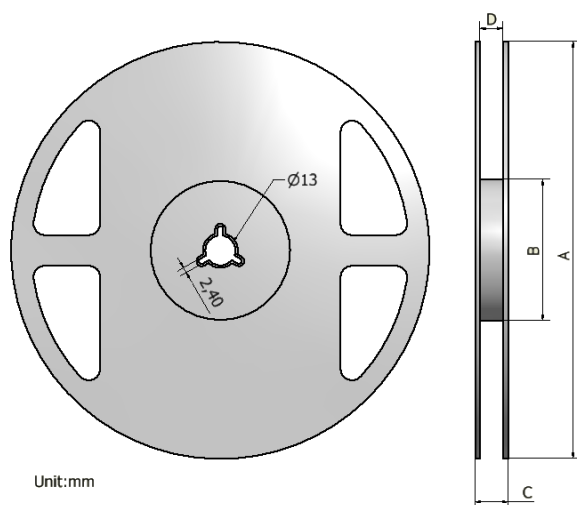

Label

SMD Metal Core Power Inductors
 MFNR3008T-□R□M
 4,000 PCS
 Lot No. _____
 FUMIWA TECHNICAL CO., LTD.

Type	A	B	C	D	Q'ty/Reel
MFNR3008	330	100	16.5	12.1	4000